

Zeus F722

mini Flight Control

Manual



Zeus F722 mini

3-6S 飞控 大疆天空端直连 FPV穿越机

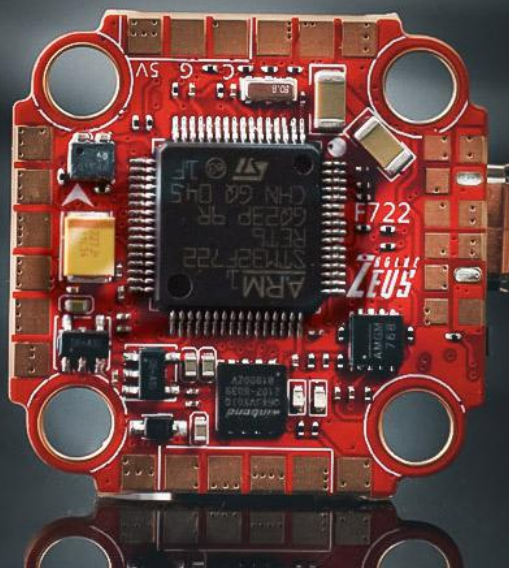

Contents

Product Specifications.....1
Interface Description.....2
Check the flight control drive.....3
Calibration accelerometer.....4
UART serial port use.....5
Select aircraft model.....6
Choose ESC protocol.....7
Select ESC telemetry.....8
Voltage and current parameters setting.....9
Setting up the receiver.....10
VTX serial port use. VTX uses OSD smart audio.....11
GPS parameters setting.....12
Check receiver signal.....13
Select flight mode startup mode.....14
OSD settings.....15
LED settings.....16
Troubleshooting.....17

.....

Package Included

Zeus F722 mini Flight Controller *1	Accessory Bag*1
--	-----------------

1. Product Specifications

Product parameters	
Model	Zeus F722 mini Flight Controller
Weight	5g
Usage	for 100mm-450mm Frame Kit
MPU	BMi270
CPU	STM32F722 RET6
Black Box	8M
Support receiver	SBUS .IBUS.DSMX/R9MM
Input Voltage	3-6S Lipo
BEC Output	9V/1.5A.5V/2A
Size	29x28mm board, M3 mounting holes

2. Interface Description

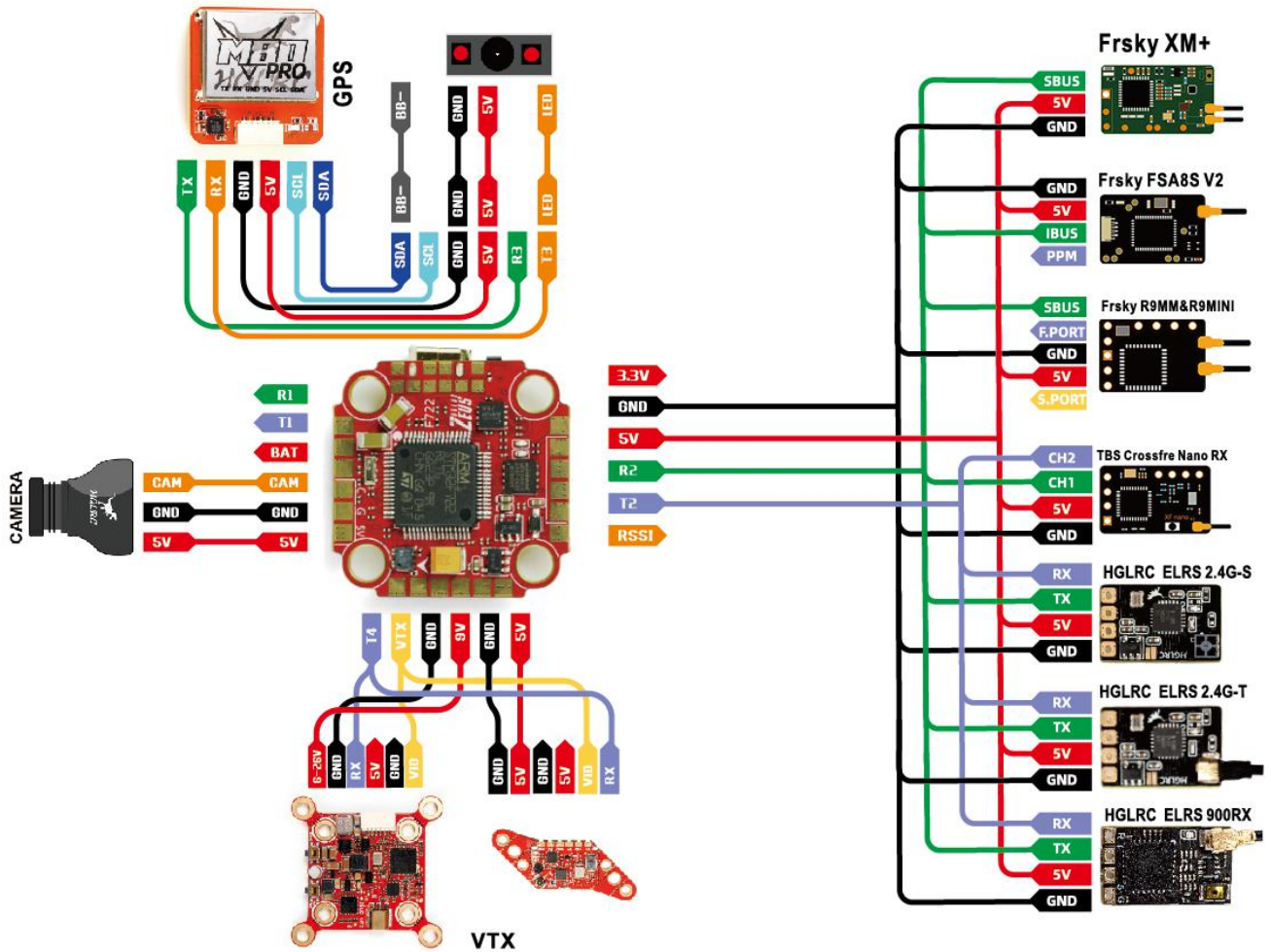

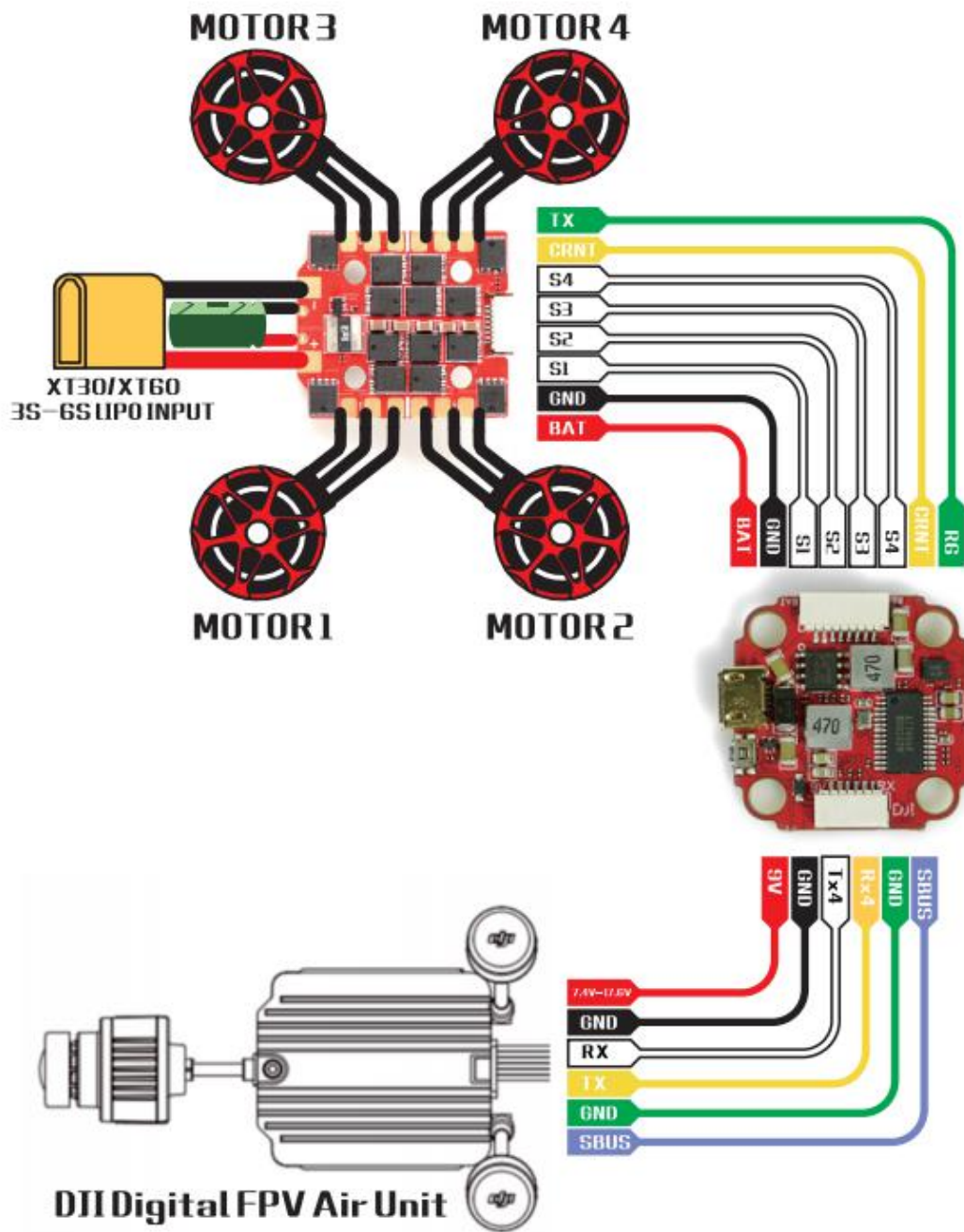

3. Check the flight control drive

1. Long Press BOOT buttons.connect USB.The system automatically install the driver



2.Driver cannot be installed, please download ImpulseRC_Driver_Fixer



3.Double-click on the run(Plug in the flight controller to automatically install the driver)

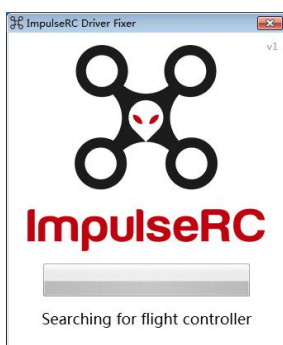

4.open betafight configurator , enter DFU mode



5. Click **Firmware Flasher** Select firmware version

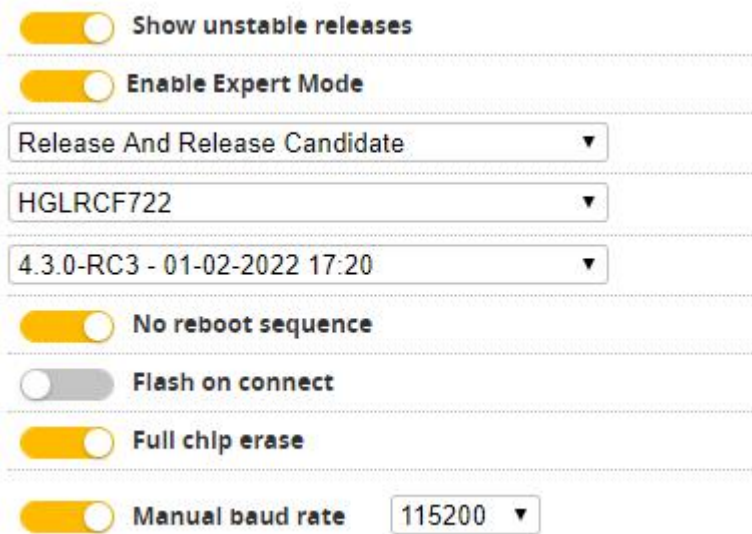

6. Click **Load Firmware [Online]** Load firmware. **Flash Firmware** Waiting for completion **Erasing ...** It will be prompted upon completion. **Programming: SUCCESSFUL**

7. open betaflyght configurator . Controller plugged into the computer. Betaflight Automatically assigned port, click “Connect” Enter setup interface (Different computer COM)

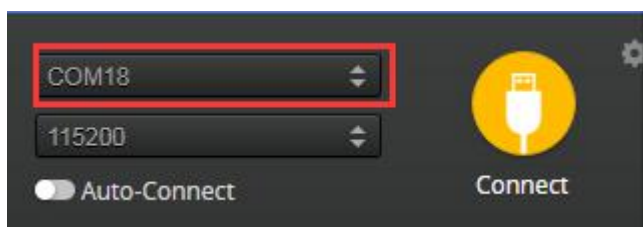

4. Calibration accelerometer

1. Put the aircraft horizontal and click “Reset Z axis”

Click again 

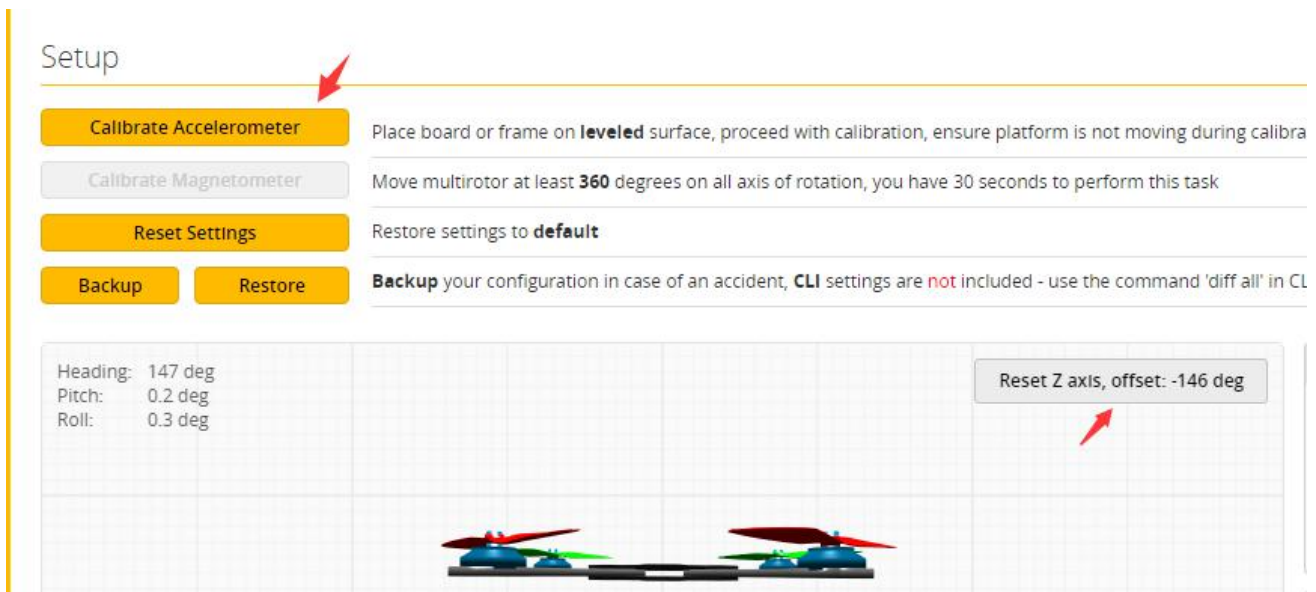

5.UART serial port use

1.UART1

2.UART2 uses the receiver

3.UART3 uses GPS

4.UART4 uses VTX image transmission uses / DJI

5.UART6 uses ESC telemetry

6. Select aircraft model

1. Click  Configuration Select model

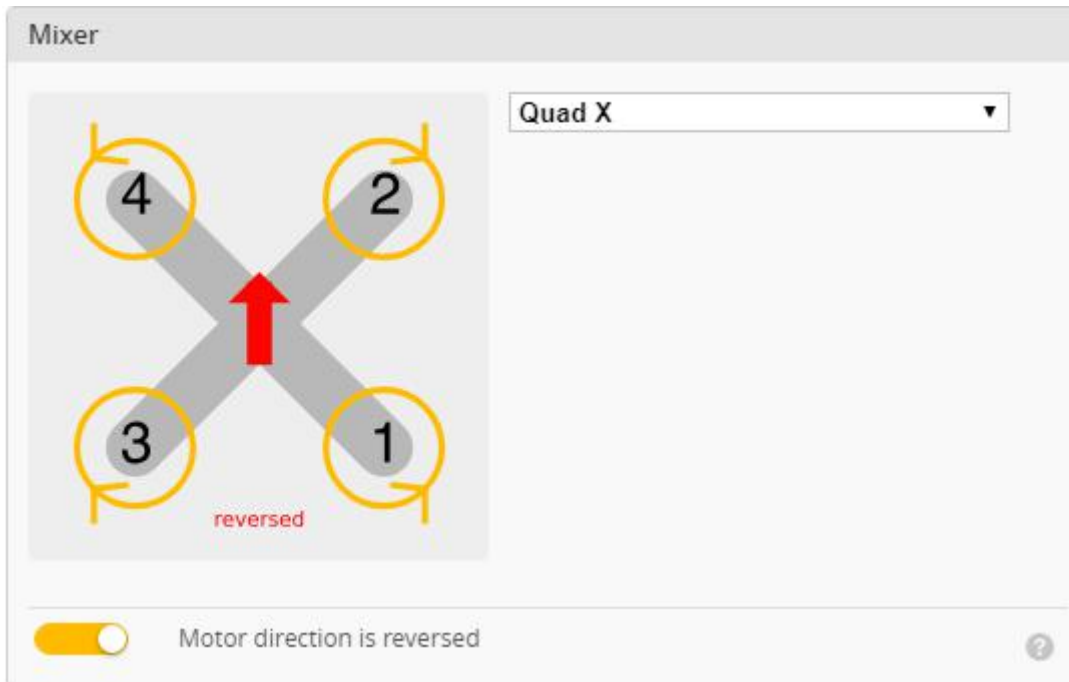

2. Click  Motors Click “**I understand the risks**” Push Master to check motor steering “**Master**” Steering can be changed at [BLHeliSuite](#)

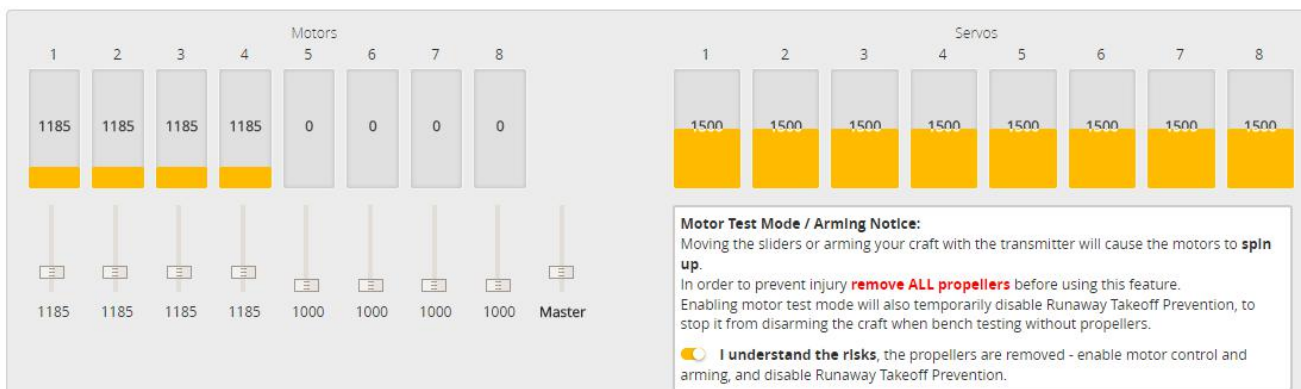

7. Choose ESC protocol

1. Choose the right ESC protocol, the optional universal protocol DSHOT600.

ESC/Motor Features

DSHOT600 ESC/Motor protocol 

MOTOR_STOP Don't spin the motors when armed

ESC_SENSOR Use KISS/BLHeli_32 ESC telemetry **over a separate wire**

Bidirectional DShot (requires supported ESC firmware)

14 Motor poles (number of magnets on the motor bell)

5.5 Motor Idle Throttle Value [percent]

8. Turn on ESC telemetry

1. Use BLHeli_32 ESC telemetry over a separate wire

ESC/Motor Features

DSHOT600 ESC/Motor protocol

MOTOR_STOP Don't spin the motors when armed

ESC_SENSOR  Use KISS/BLHeli_32 ESC telemetry **over a separate wire**

Bidirectional DShot (requires supported ESC firmware)

14 Motor poles (number of magnets on the motor bell)

5.5 Motor Idle Throttle Value [percent]

2. Open ESC telemetry serial port. TX on the ESC needs to be connected to the RX6 on the flight controller to use the ESC telemetry

Ports WIKI

Note: not all combinations are valid. When the flight controller firmware detects this the serial port configuration will be reset.
Note: Do NOT disable MSP on the first serial port unless you know what you are doing. You may have to reflash and erase your configuration if you do.

Identifier	Configuration/MSP	Serial Rx	Telemetry Output	Sensor Input	Peripherals
USB VCP	<input checked="" type="checkbox"/> 115200	<input type="checkbox"/>	Disabled AUTO	Disabled AUTO	Disabled AUTO
UART1	<input type="checkbox"/> 115200	<input type="checkbox"/>	Disabled AUTO	Disabled AUTO	Disabled AUTO
UART2	<input type="checkbox"/> 115200	<input checked="" type="checkbox"/>	Disabled AUTO	Disabled AUTO	Disabled AUTO
UART3	<input type="checkbox"/> 115200	<input type="checkbox"/>	Disabled AUTO	GPS 115200	Disabled AUTO
UART4	<input checked="" type="checkbox"/> 115200	<input type="checkbox"/>	Disabled AUTO	Disabled AUTO	Disabled AUTO
UART6 	<input type="checkbox"/> 115200	<input type="checkbox"/>	Disabled AUTO	ESC AUTO	Disabled AUTO

3.View telemetry data on OSD

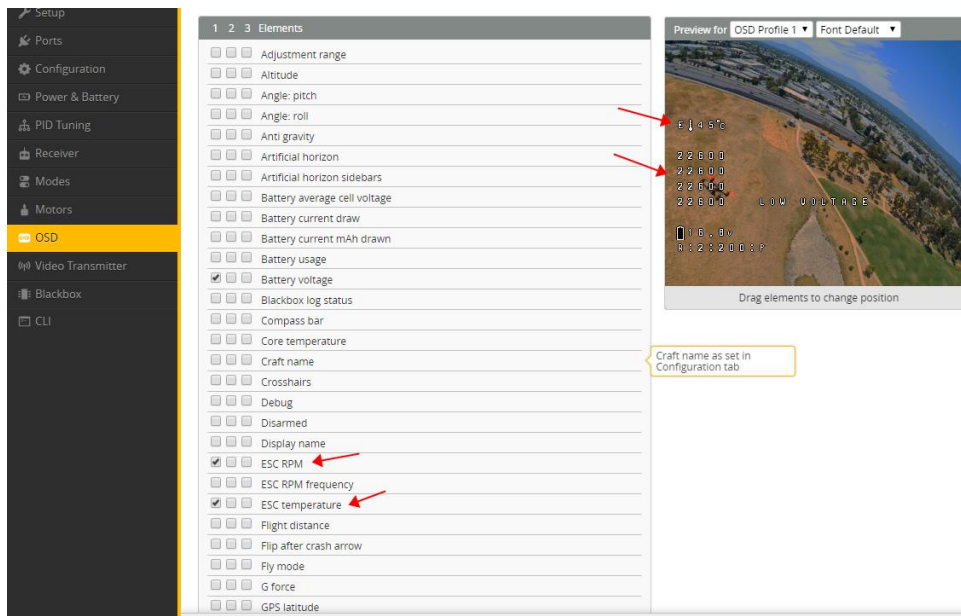

9.Voltage and current parameters setting

1.Click **Power & Battery** Setting parameters

Power & Battery

Battery	
Onboard ADC	Voltage Meter Source
Onboard ADC	Current Meter Source
3.3	Minimum Cell Voltage
4.3	Maximum Cell Voltage
3.5	Warning Cell Voltage
0	Capacity (mAh)

Voltage Meter	
Battery	0.3 V
110	Scale
10	Divider Value
1	Multiplier Value

10. Setting up the receiver

1. Receiver connection diagram

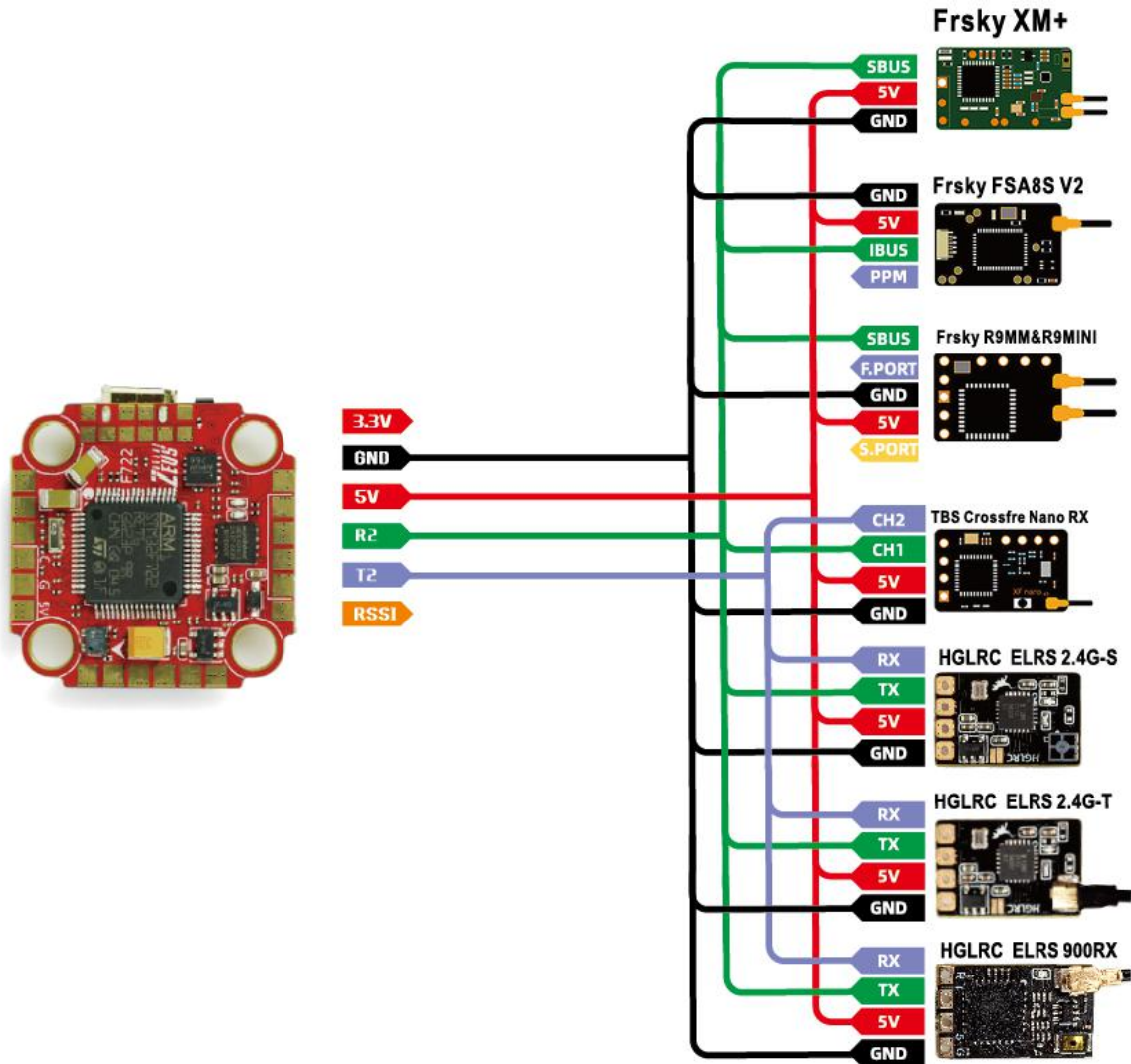

2. Click have found “UART2” Open the receiver serial port

Ports WIKI

Note: not all combinations are valid. When the flight controller firmware detects this the serial port configuration will be reset.
 Note: Do NOT disable MSP on the first serial port unless you know what you are doing. You may have to refresh and erase your configuration if you do.

Identifier	Configuration/MSP	Serial Rx	Telemetry Output	Sensor Input	Peripherals
USB VCP	<input checked="" type="checkbox"/> 115200	<input type="checkbox"/>	Disabled AUTO	Disabled AUTO	Disabled AUTO
UART1	<input type="checkbox"/> 115200	<input type="checkbox"/>	Disabled AUTO	Disabled AUTO	Disabled AUTO
UART2	<input type="checkbox"/> 115200	<input checked="" type="checkbox"/>	Disabled AUTO	Disabled AUTO	Disabled AUTO
UART3	<input type="checkbox"/> 115200	<input type="checkbox"/>	Disabled AUTO	GPS 115200	Disabled AUTO
UART4	<input checked="" type="checkbox"/> 115200	<input type="checkbox"/>	Disabled AUTO	Disabled AUTO	Disabled AUTO
UART6	<input type="checkbox"/> 115200	<input type="checkbox"/>	Disabled AUTO	ESC AUTO	Disabled AUTO

3. Set the SBUS receiver

Receiver

Serial-based receiver (SPEKSAT, 5 ▼) Receiver Mode

Note: Remember to configure a Serial Port (via Ports tab) and choose a Serial Receiver Provider when using RX_SERIAL feature.

SBUS ▼ Serial Receiver Provider

4. Set the DSMX receiver

Receiver

Serial-based receiver (SPEKSAT, 5 ▼) Receiver Mode

Note: Remember to configure a Serial Port (via Ports tab) and choose a Serial Receiver Provider when using RX_SERIAL feature.

SPEKTRUM2048 ▼ Serial Receiver Provider

11.VTX serial port use. VTX uses OSD smart audio

1.VTX connection diagram

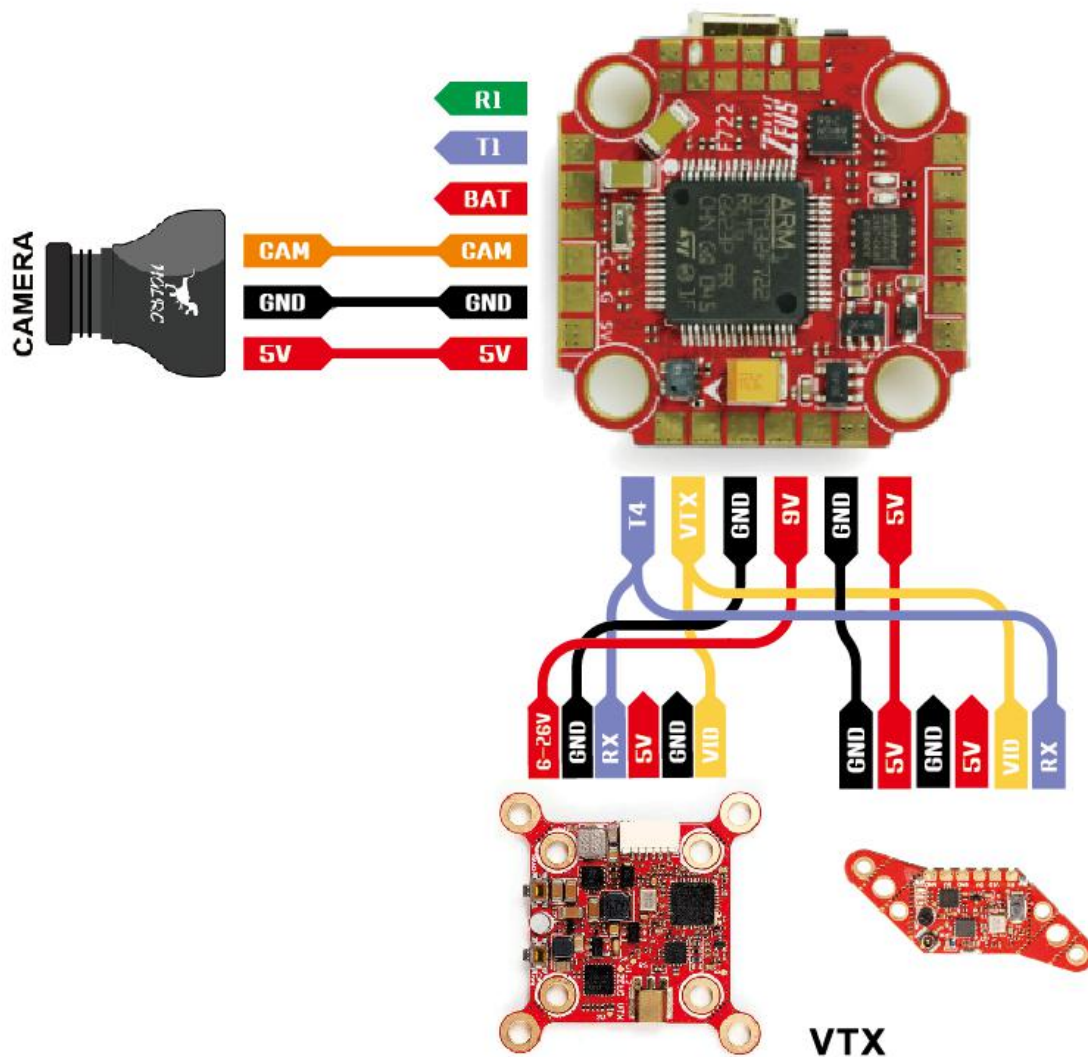

2. DJI FPV Air Unit wiring

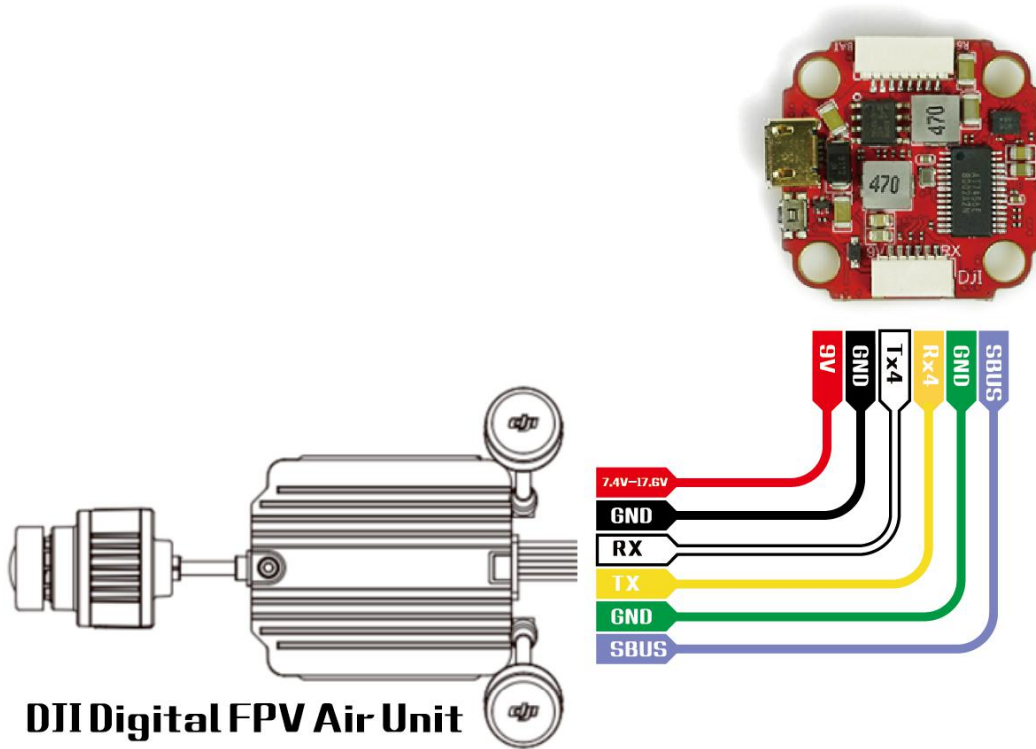

3. VTX serial port opens. The protocol is selected according to its own VTX protocol.

Ports WIKI

Note: not all combinations are valid. When the flight controller firmware detects this the serial port configuration will be reset.
Note: Do **NOT** disable MSP on the first serial port unless you know what you are doing. You may have to refresh and erase your configuration if you do.

Identifier	Configuration/MSP	Serial Rx	Telemetry Output	Sensor Input	Peripherals
USB VCP	<input checked="" type="checkbox"/> 115200	<input type="checkbox"/>	Disabled AUTO	Disabled AUTO	Disabled AUTO
UART1	<input type="checkbox"/> 115200	<input type="checkbox"/>	Disabled AUTO	Disabled AUTO	Disabled AUTO
UART2	<input type="checkbox"/> 115200	<input checked="" type="checkbox"/>	Disabled AUTO	Disabled AUTO	Disabled AUTO
UART3	<input type="checkbox"/> 115200	<input type="checkbox"/>	Disabled AUTO	GPS 115200	Disabled AUTO
UART4	<input type="checkbox"/> 115200	<input type="checkbox"/>	Disabled AUTO	Disabled AUTO	Disabled AUTO
UART6	<input type="checkbox"/> 115200	<input type="checkbox"/>	Disabled AUTO	ESC AUTO	<div style="border: 1px solid red; padding: 2px;"> Disabled AUTO Disabled Blackbox logging VTX (TBS SmartAudio) VTX (iFC Transp) Camera (RunCam Protocol) Benevake LIDAR OSD (FrSky Protocol) </div>

4. DJI serial port opens

Ports WIKI

Note: not all combinations are valid. When the flight controller firmware detects this the serial port configuration will be reset.
Note: Do **NOT** disable MSP on the first serial port unless you know what you are doing. You may have to refresh and erase your configuration if you do.

Identifier	Configuration/MSP	Serial Rx	Telemetry Output	Sensor Input	Peripherals
USB VCP	<input checked="" type="checkbox"/> 115200	<input type="checkbox"/>	Disabled AUTO	Disabled AUTO	Disabled AUTO
UART1	<input type="checkbox"/> 115200	<input type="checkbox"/>	Disabled AUTO	Disabled AUTO	Disabled AUTO
UART2	<input type="checkbox"/> 115200	<input checked="" type="checkbox"/>	Disabled AUTO	Disabled AUTO	Disabled AUTO
UART3	<input type="checkbox"/> 115200	<input type="checkbox"/>	Disabled AUTO	GPS 115200	Disabled AUTO
UART4	<input checked="" type="checkbox"/> 115200	<input type="checkbox"/>	Disabled AUTO	Disabled AUTO	Disabled AUTO
UART6	<input type="checkbox"/> 115200	<input type="checkbox"/>	Disabled AUTO	ESC AUTO	Disabled AUTO

5. Use OSD to adjust VTX

which displays information like battery voltage and mAh consumed while you fly. In addition, the Betaflight OSD can be used to configure the quadcopter, making in-field adjustments and tuning more convenient.

MODE2

MODE1

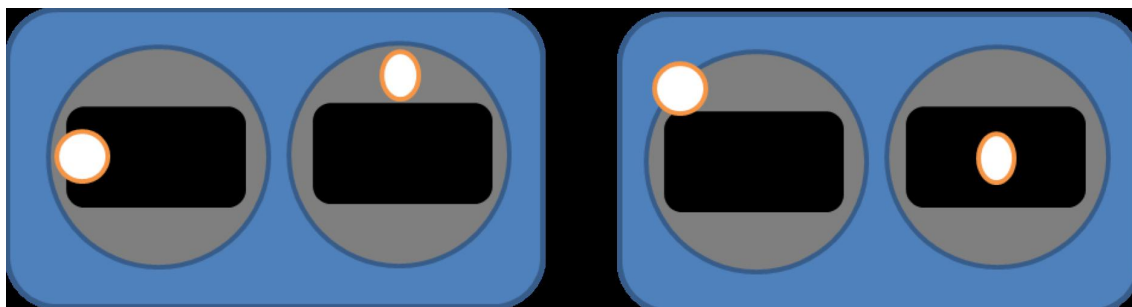

The graphics above show the stick command to bring up the OSD menu. The stick command is: throttle centered, yaw left, pitch forward. The exact stick command therefore depends on which mode your transmitter sticks are in.

In the OSD menu, use pitch up/down to move the cursor between menu items. When a menu option has a > symbol to the right of it, this indicates that it contains a sub-menu. Roll-right will enter the sub-menu. For example, in the screen to the right, moving the cursor to “Features” and then moving the roll stick to the right will enter the “Features” sub-menu.

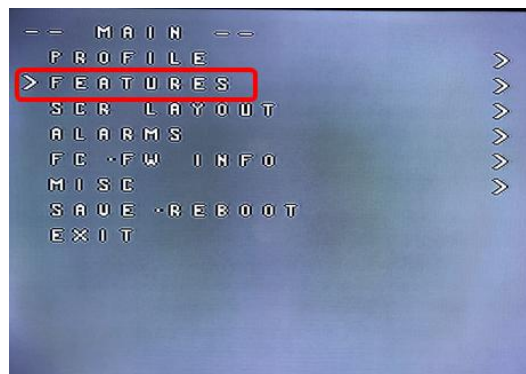

If you are using a video transmitter that supports remote configuration, enter the “Features” menu to configure the vTX. From there, enter either “VTX SA” if you are using SmartAudio (TBS Unify) or “VTX TR” if you are using IRC Tramp Telemetry.

To adjust PIDs, rates, and other tuning-related parameters, enter the “Profile” sub-menu.

In the “Scr Layout” sub-menu, you can move the OSD elements (like battery voltage, mAh, and so forth) around on the screen.

The “Alarms” sub-menu lets you control when the OSD will try to alert you that battery voltage is too low or mAh

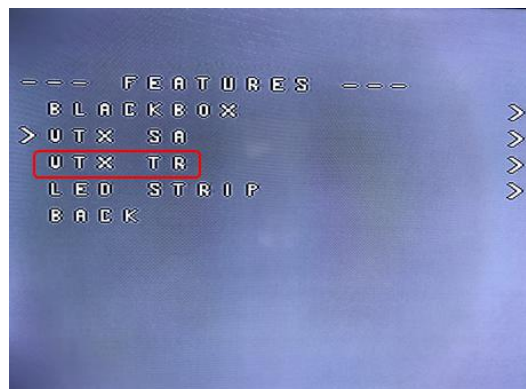

consumed is too high.

When a parameter can be modified, the parameter's current value will be shown on the right-hand side of the screen. In this case, roll left/right will adjust the parameter up and down.

The screen to the right shows the current vTX settings. From here, you can change the frequency band, channel, and power level of the video transmitter. After making the changes, move the cursor to "Set" and press roll-right to confirm the settings.

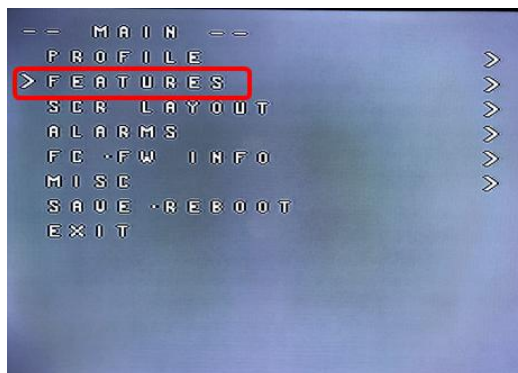

12.GPS parameters setting

1.GPS connection diagram

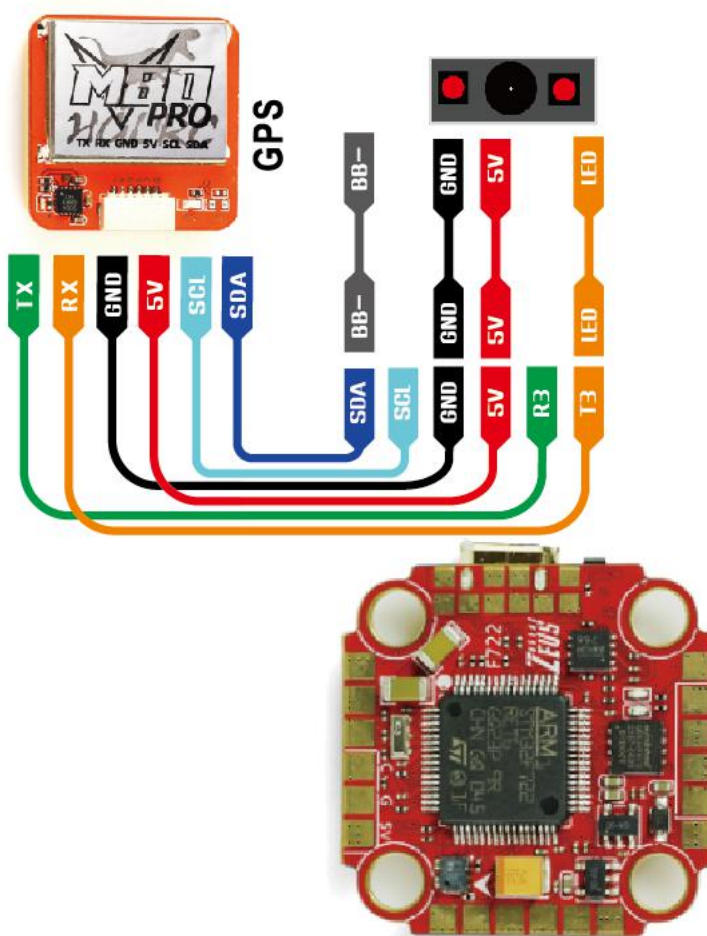

2. Open the GPS serial port

Ports

WIKI

Note: not all combinations are valid. When the flight controller firmware detects this the serial port configuration will be reset.
Note: Do **NOT** disable MSP on the first serial port unless you know what you are doing. You may have to reflash and erase your configuration if you do.

Identifier	Configuration/MSP	Serial Rx	Telemetry Output	Sensor Input	Peripherals
USB VCP	<input checked="" type="checkbox"/> 115200	<input type="checkbox"/>	Disabled AUTO	Disabled AUTO	Disabled AUTO
UART1	<input type="checkbox"/> 115200	<input type="checkbox"/>	Disabled AUTO	Disabled AUTO	Disabled AUTO
UART2	<input type="checkbox"/> 115200	<input checked="" type="checkbox"/>	Disabled AUTO	Disabled AUTO	Disabled AUTO
UART3	<input type="checkbox"/> 115200	<input type="checkbox"/>	Disabled AUTO	GPS 115200	Disabled AUTO
UART4	<input checked="" type="checkbox"/> 115200	<input type="checkbox"/>	Disabled AUTO	Disabled AUTO	Disabled AUTO
UART6	<input type="checkbox"/> 115200	<input type="checkbox"/>	Disabled AUTO	ESC AUTO	Disabled AUTO

3. When using the GPS function, remember to configure the serial port (via the Ports tab).

GPS

GPS GPS for navigation and telemetry

Note: Remember to configure a Serial Port (via Ports tab) when using GPS feature.

NMEA Protocol

Auto Baud

Auto Config

Set Home Point Once

None Ground Assistance Type

13. Check receiver signal

1. Click  Receiver Check the remote control output signal

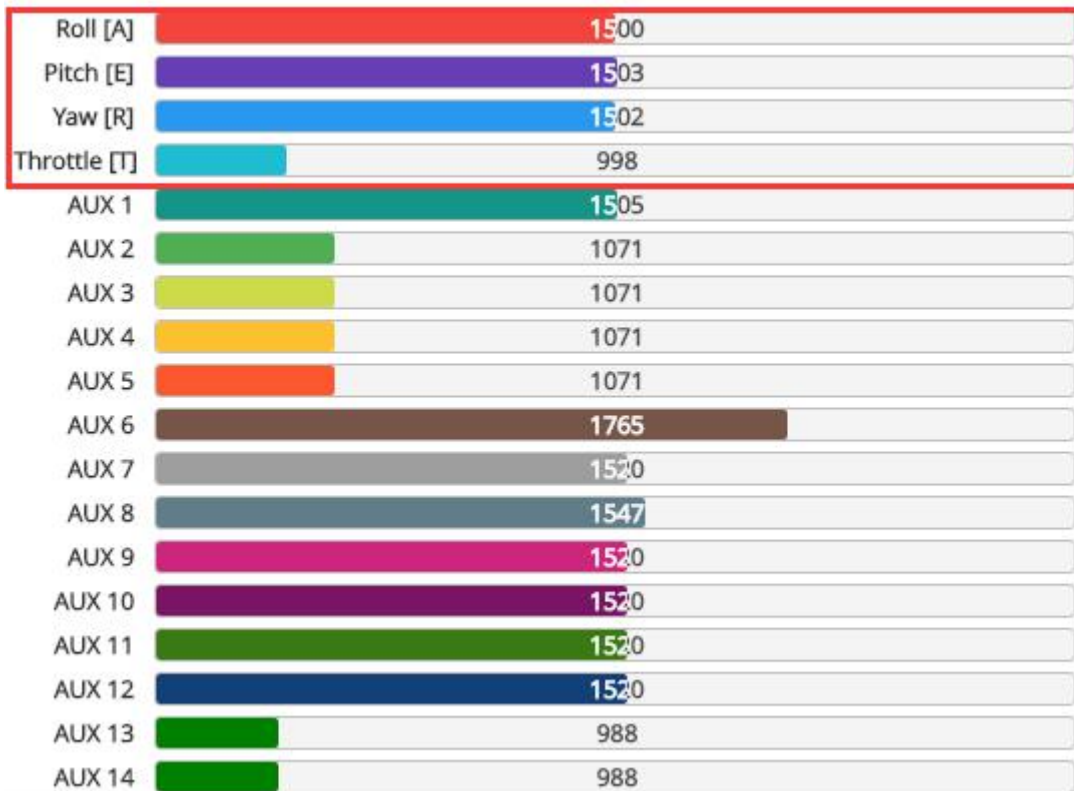

14. Select flight mode startup mode

1. Click  Modes set up the function of remote control switch across the channel (below are for reference only)

Modes WIKI

Use ranges to define the switches on your transmitter and corresponding mode assignments. A receiver channel that gives a reading between a range min/max will activate the mode. Remember to save your settings using the Save button.

Show/hide unused modes

ARM ✕

AUX 1 ✕

Min: 1300 Max: 2100

900 1000 1200 1400 1500 1600 1800 2000 2100

ANGLE ✕

AUX 1 ✕

Min: 1300 Max: 2100

900 1000 1200 1400 1500 1600 1800 2000 2100

15. OSD settings

1. Click **OSD** the OSD Settings, according to the need to choose, drag the OSD schematic diagram of the parameters can be adjusted.

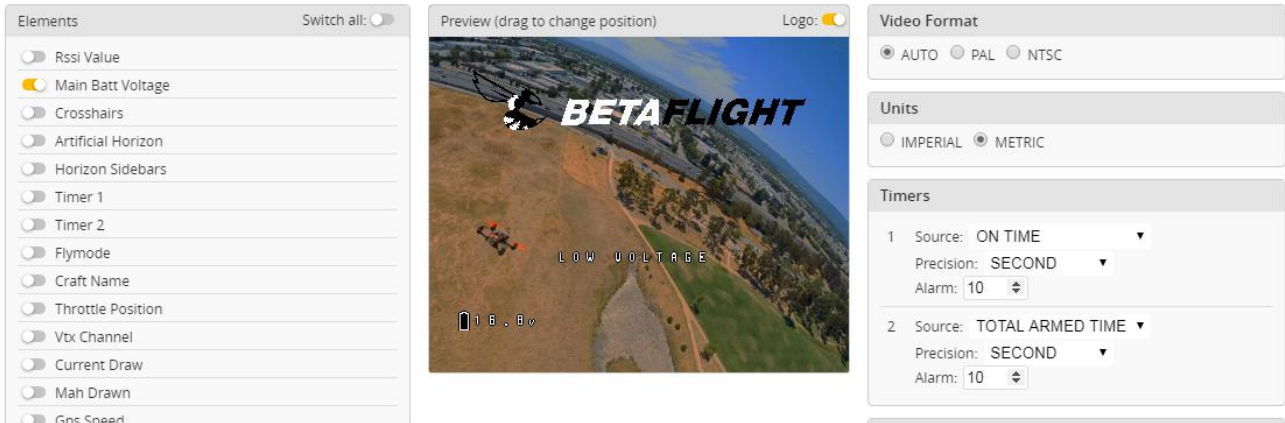

16. LED settings

1. Click **Configuration** Turn on LED support



2. Click **LED Strip**. Click **Wire Ordering Mode** set according to need

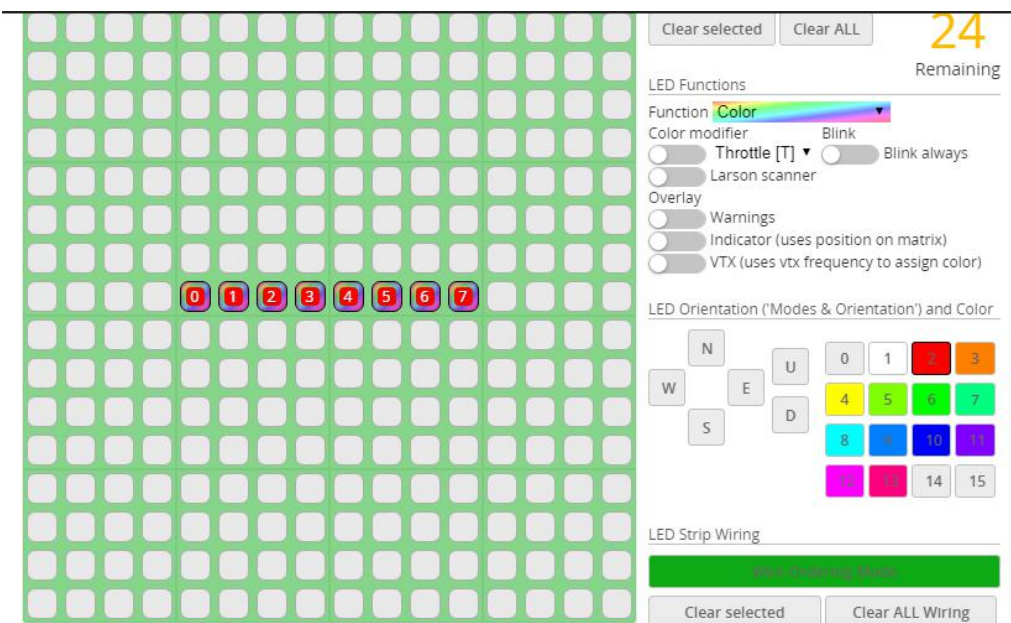

17.Troubleshooting

Warning:

Please read the cautions as follows, otherwise stability of your flight controller cannot be ensured, your flight controller will even get damaged.

- Keep focus on the polarity. Check carefully before power supply.
- Cut off the power when you connect, plug and pull anything.
- The refresh rate of PID and Gyroscope is up to 3.2K/3.2K.

after sales question:

1. After receiving the goods, it is found that the product can not be used normally. If the return to the factory is a quality problem, the repair service will be provided free of charge.
2. If the product is damaged due to improper operation, the repair service may be provided under the condition that the inspection can be repaired.
3. For domestic customers, please contact the after-sales service personnel.
For overseas customers, please contact the official website for after-sales service.

Product daily problems

1.OSD garbled:

If you find garbled characters, please open Betaflight, click “OSD” .and click “Font Manager” clicks on “Upload Font” to update

1. When plugged in the battery, the aircraft does not pass the self-test without "BBB" sound. There is only one sound.

Please check if the ESC agreement is correct

3.The spin of the aircraft keeps spinning

1. Please check if the propeller is correct
2. Please check if the motor direction is correct